



# HOTEAM™ HTQF ACTIVE POWER FILTER

POWER QUALITY ULTIMATE SOLUTION





## ABOUT US

Hoteam Electric is the leading company specializing in providing power quality solutions for utility and industry customers to ensure efficient and reliable operation of electrical systems. The company's broad range of products includes active power filters (APFs), SVGs (also known as STATCOMs), capacitor banks, MCRs and many other customized solutions.

Hoteam Electric plays a key role in the rapid growing market of active power filters. In order to cater for different requirements of both industrial and commercial applications, Hoteam Electric offers a wide range of active power filters (APFs) available in different forms, dimensions and current ratings. The whole Hoteam APF family includes floor standing HTQF floor-standing APFs, and rack-mount/wall-mount HTQF APFs.



Product Patent Certificates and Control Software Copyright Certificates

## WORKING PRINCIPLE

Hoteam HTQF active power filter (APF) provides a truly effective harmonic solution with the advanced active harmonic compensation technology. HTQF APF behaves like a harmonic current generator. It measures the harmonic current generated by nonlinear loads and cancels the harmonics by generating an opposite phase harmonic current with the same amplitude and injecting it to the line, making source current sinusoidal.

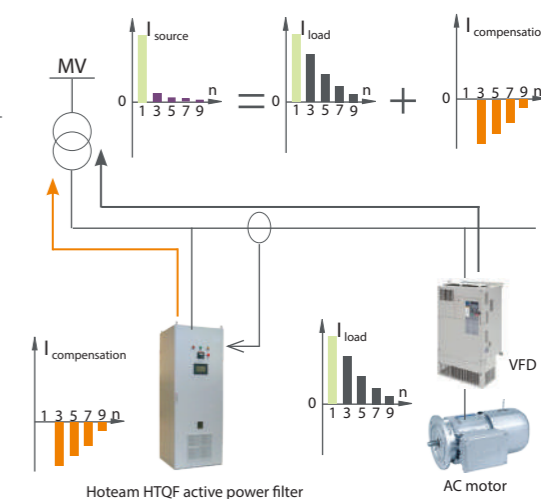

## TYPICAL APPLICATIONS

- » Steel plants
- » Oil and gas exploration
- » Automotive industry
- » Pulp and paper industry
- » Chemical industry
- » Mining industry
- » Ports and shipyards
- » Textile industry
- » Rubber and plastic industry
- » Water treatment industry
- » Printing and package industry
- » Data centers and IT facilities
- » Metro stations and railway stations
- » Medical facilities
- » High-rise office buildings
- » Theme parks and shopping malls



## THE HOTEAM ELECTRIC SOLUTION FOR ACTIVE HARMONIC FILTERING IN DATA CENTERS AND MODERN BUILDINGS



## POWER QUALITY CHALLENGES IN MISSION-CRITICAL FACILITIES AND MODERN BUILDINGS... WHICH WE CLEARLY UNDERSTAND



### KEY PRODUCT FEATURES

- » Hot-swappable modular design
- » Stunning power density and compact size
- » Directly compatible with 19" racks
- » Easy installation and maintenance
- » Powerful controller based on dual-DSP architecture
- » Advanced 3-level IGBT inverter topology
- » Compensation efficiency > 97%
- » Cancel up to 50<sup>th</sup> harmonic
- » Amorphous alloy reactors for low noise and enhanced energy efficiency
- » Power loss < 3%
- » EMC design by industrial grade standard
- » CE marking
- » Harmonic selection compensation and four programmable task-priority modes
- » Load balancing function
- » 4.3 inch menu-based LCD touch-screen
- » CT location programmable for single module installation

### TYPICAL APPLICATIONS

- » Data centers and telecom facilities
- » Medical facilities
- » Shopping malls and theme parks
- » Culture and performance centers
- » High-rise office buildings
- » Large HVAC installation and tunnel ventilation
- » Food processing industry
- » Water/wastewater treatment
- » Automotive industry with many single phase loads
- » Automated production&assembly lines
- » Logistic centers with large conveyor systems



### INCREASING POWER AVAILABILITY AND ENERGY EFFICIENCY REQUIREMENTS

Mission continuity is always a crucial aspect in infrastructures like data centers, telecom facilities as well as hospitals, where power availability must be ensured 24/7/365 to avoid data losses and downtime of business operations. On the other hand, along with many other modern architectures, these mission-critical facilities are faced with constant evolutions in energy demands, both in terms of power rating and energy efficiency.

### DILEMMA BETWEEN NON-LINEAR LOADS INTRODUCED FOR POWER DEMANDS AND POWER QUALITY

To ensure the power availability and energy efficiency, commercial applications are making an increasing use of UPS, variable frequency drives (VFDs) for ventilation, switching mode power supply (SMPS), fluorescent lamps. All these loads are non-linear and inject considerable harmonics back into the grid. Consequently, the widespread use of those non-linear loads backfires and pose serious threat to power availability.

### TRIPLIN HARMONICS AND RELATED NEUTRAL CURRENT ISSUE

Prevailing single phase loads in modern buildings, like computers and lightings, by their nature, can generate considerable triplen harmonics. The triplen harmonics are defined as the odd multiples of the 3<sup>rd</sup> harmonic (3<sup>rd</sup>, 9<sup>th</sup>, 15<sup>th</sup>, etc). They are of particular concern because triplen harmonics add up in the neutral conductor and can overload power supply cables, and unless the neutral is sufficiently oversized, this can present a serious fire hazard to buildings.



## NO TRADE-OFF BETWEEN PERFORMANCE AND COMPACT SIZE

Technologies behind no-compromise harmonic compensation...

## CLEANER AND SAFER GRIDS, AS SIMPLE AS HTQF APF MODULES



Easy installation

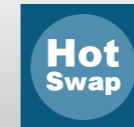

Hot-swappable



Scalability



Cost-effective

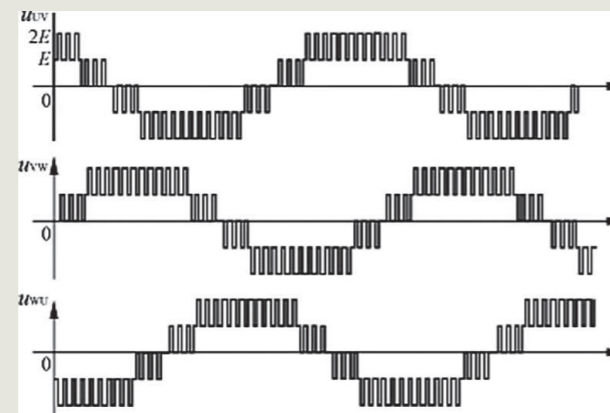
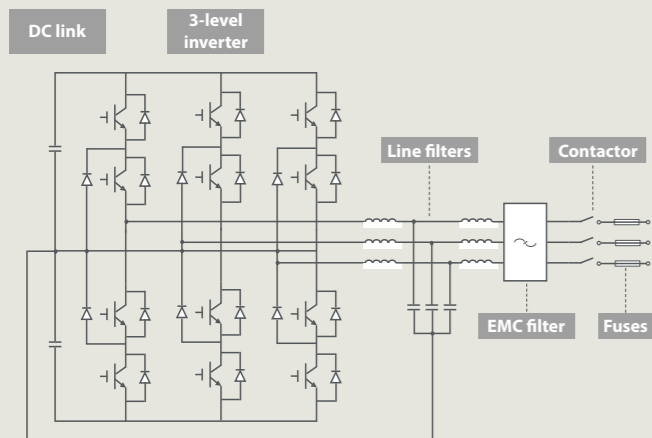

### PROVEN TECHNOLOGIES INHERITED FROM HOTEAM HTQF APF FAMILY

The HTQF active power filter family is based on a unified control platform and a consistent design concept. As an integral member of the Hoteam HTQF APF family, HTQF APF modules, although highly compact, features the same cutting-edge performance as its big brothers.

Our engineers have successfully extended all the standard functions in the floor standing HTQF APF systems to HTQF APF modules, including harmonic selection compensation according to harmonic frequency, as well as four programmable task-priority modes for harmonic filtration and var compensation. These two features allow users to squeeze the APF module performance to the last drop according to every possible power quality site conditions.

### 3-LEVEL IGBT INVERTER TOPOLOGY

At the heart of HTQF APF module is the 3-level IGBT inverter, which can be considered as an innovation that has huge impact on efficiency and footprint of modular active power filters.

In general, compared with the conventional 2-level inverter which comprises of six IGBTs, the 3-level topology utilizes 12 IGBTs. The doubled number of IGBTs and the split DC link significantly lower the ripple current of the output current and therefore, improve the efficiency and downsize the EMC filter and line filters for a smaller footprint.

### STUNNING POWER DENSITY

Thanks to the 3-level topology, Hoteam HTQF APF module can achieve 150A harmonic compensation in compact dimensions of 500mm\*580mm\*272 mm.

Hoteam HTQF APF modules are active power filters designed for applications where simplicity is the key requirement.

When you need a compact APF solution doing its job without extra hassle, HTQF APF module is the one you should take a closer look at.

### EASY HANDLING AND INSTALLATION

HTQF rack-mount APF modules are equipped with slot adapter sockets to facilitate quick installation in all kinds of enclosures. Additionally, the well-thought-out fool-proofing mechanisms, like the self-positioning terminal connectors, are used to guarantee correct connection and significantly simplify the commissioning, which used to be complicated.

Also, whether wall mounted or placed on a rack, HTQF APF module, with its compact size and the flexible installation methods, will fit perfectly in a restricted space where floor standing APF cannot access. As a result, in a retrofit project, no damage or modification to the building is needed.

### HOT-SWAPPABLE AND REDUCED MTTR (MEAN TIME TO REPAIR)

The current transformers can be automatically short-circuited and disconnected when a HTQF APF module is removed. The APF system decentralizes the control units in each APF module and a module can be extracted from the rack via front access. As a result, a module can be easily added or replaced in a few minutes while the whole APF system is still in operation, to minimize service time on site.

### “PAY AS YOU GO” SCALABILITY AND LOWER COST OF OWNERSHIP

Each HTQF APF module is a fully independent APF system and the APF system expansion is extremely easy. With the evolving power demands, the scalability allows the user to invest only for the compensation capacity required in the short-term and plug in new modules whenever the harmonic compensation capacity needs to be upgraded.

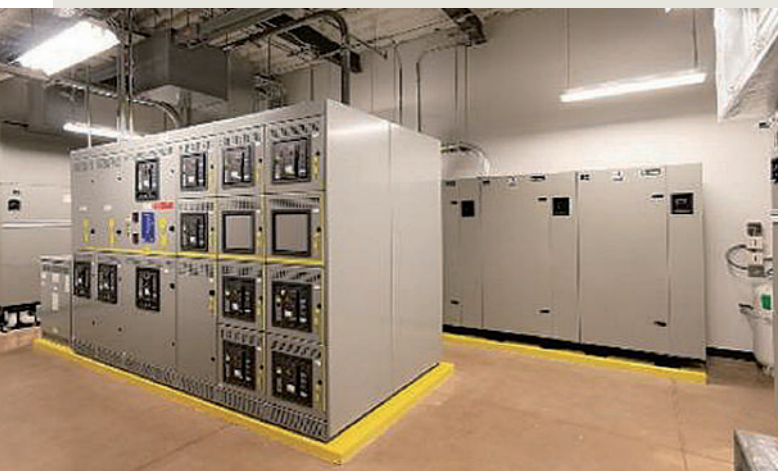

## PANEL BUILDERS ELECTRICAL SYSTEM INTEGRATORS

Solving Harmonic Issues  
Whatever The Integration  
Restriction Is

### UNIVERSAL COMPATIBILITY WITH ENCLOSURES OF ALL KINDS

HTQF APF modules are directly compatible with the existing 19" racks in data centers without additional expense. For centralized compensation applications in switchgear rooms, the modules can be integrated in existing cabinets to operate in parallel with other distribution switchgears.

### BETTER INTEGRATION TO VARIOUS OPERATION ENVIRONMENTS THROUGH LOCAL CUSTOMIZATION

No matter what the local preference for cabinets or the protection class requirement is, HTQF APF module can always be integrated in a customized sub-distribution board by local panel makers or electrical system integrators to keep appearance consistency in the distribution switchgear rooms and meet local regulations.

## MODEL DESCRIPTION

HTQF 3L – 0.4 /100A – W

#### Product Name

HTQF Hoteam HTQF active power filter

#### Connection Method

3L 3 phase 3 wire system  
4L 3 phase 4 wire system

#### Nominal Voltage

0.4 0.4kV

#### Installation

C Floor standing  
W Wall-mount  
R Rack-mount

#### Compensation Current

30A - 150A per module  
30A - 750A per cabinet

## SPECIFICATIONS

General electrical parameters	
Nominal voltage	400V -20/+15%
Nominal frequency	50/60Hz ±5%
Performance specifications	
Compensation current	30A, 60A, 100A, 120A, 150A per module
Compensation efficiency	Above 97%
Harmonic spectrum	2 <sup>nd</sup> to 50 <sup>th</sup> harmonics
Harmonic compensation selection	2 <sup>nd</sup> to 50 <sup>th</sup> harmonics all can be selected individually, up to 20 harmonics can be filtered simultaneously
Response time	Instantaneous response time < 0.1ms Full response time < 20ms
Neutral current compensation	3 times the RMS line current, capable of zero-sequence harmonic compensation (4-wire model)
Power factor correction	Power factor programmable from 0.6 (inductive) to 0.6 (capacitive)
Load balancing	Programmable load balancing between phases
Protections	Over-voltage, Under-voltage, Over-current, Over-temperature, etc.
Power loss	Less than 3% of rated power
HMI & communication	
Display	4.3-inch menu-based touch screen with English, Spanish, Italian, Polish and Korean Interface, other language available upon request
Communication interface	Modbus RTU (RS232/485) capable of multi-module communication
Operation configuration	
Parallel operation	Up to 12 modules (different rated currents capable)
CT requirements	3 CTs required (class 1 or better), X/5A as default, X/1A compatible
CT location	CT location programmable on site for single unit applications. When multiple APFs operate in parallel, please specify source side or load side when placing order.
Color	RAL9004 Black, other color on request
Environmental conditions	
Protection class	IP20 (higher protection class available on request)
Operation environment	Indoor, clean environment
Operation temperature	-10 ~ 40°C (higher operation temperature allowed with derating)
Storage temperature	-25 ~ 70°C
Humidity	Maximum 95% non-condensation
Altitude	1000m (higher operation altitude allowed with derating)



CE certifications



EMC



LVD

## PRODUCT SELECTION TABLES

HTQF 3L-0.4/ ■■■A-R		HTQF 4L-0.4/ ■■■A-R				
Model		30	60	100	120	150
Wire system		3 phase-3 wire / 3 phase-4 wire				
Compensation current A		30	60	100	120	150
Var compensation kvar		20	40	66	80	100
Approx. weight kg		23	28	54	58	62
Panel		Compatible with 19" rack				
Installation		Rack-mount				
Width mm		440	440	440	500	500
Depth mm		445	575	575	580	580
Height mm		150	177	232	270	270
Cable entry		Back entry				

HTQF 3L-0.4/ ■■■A-W		HTQF 4L-0.4/ ■■■A-W				
Model		30	60	100	120	150
Wire system		3 phase-3 wire / 3 phase-4 wire				
Compensation current A		30	60	100	120	150
Var compensation kvar		20	40	66	80	100
Approx. weight kg		23	28	54	58	62
Installation		Wall-mount				
Width mm		440	440	440	500	500
Depth mm		195	177	290	270	270
Height mm		445	575	575	580	580
Cable entry		Top entry				

## HTQF APF SOLUTIONS IN REAL-WORLD SITUATION

Depending on the site conditions, such as the load profile and distribution network configuration, as well as the desired compensation effect, there are various kinds of compensation solutions to obtain the most cost-effectiveness. According to the location of APF in the network, the harmonic compensation solutions can be categorized as centralized compensation, group compensation and local compensation.

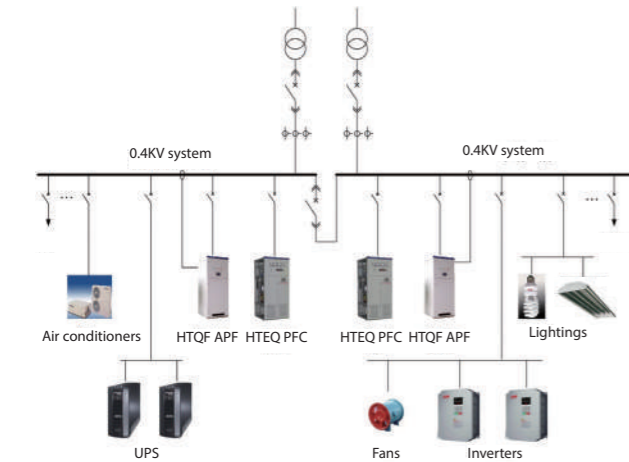

### CENTRALIZED HARMONIC COMPENSATION

Centralized compensation is suited for distributed power distribution network where the large number of nonlinear loads with small rated power are well spread out. As a result, Hoteam HTQF active power filters are preferably installed on the secondary side of transformers to compensate harmonics globally.

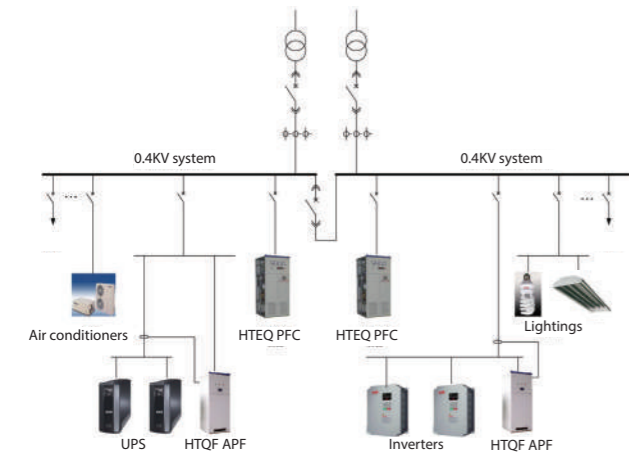

### GROUP HARMONIC COMPENSATION

Group compensation, on the other hand, is suitable for the power distribution network where the nonlinear loads are mainly located at certain branches. For example, a Hoteam HTQF active power filter is fitted in a branch with multiple sets of high-power rated industrial UPS.

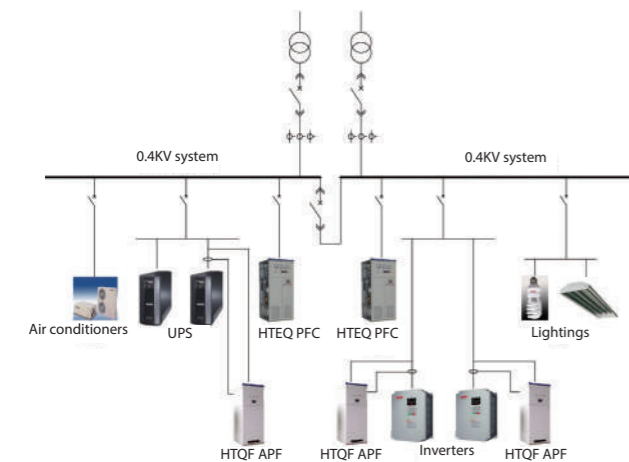

### LOCAL HARMONIC COMPENSATION

For power distribution network in which the nonlinear loads, such as high-power rated inverters, thyristor power supplies and induction furnaces, are located closely, a set of Hoteam HTQF active power filter can compensate locally.

## CASE STUDY

### HOTEAM HTQF APF IN A GOLD MINE



Mining industry has a unique load portfolio where mining hoists, pumps and ventilation fans, crushers, conveyor systems and ball mills are the predominant loads and good power quality is an essential aspect for reliable operation for the whole site. However, whether driven by variable frequency drives (VFDs), rectifiers or just cycloconverters, drive system in mining industry would generate considerable harmonic distortions which are characterized by the significant 5th and 7th harmonics.

As a result, the process shops of the Jinchiling Gold Mine suffered from high level of harmonic distortion which in turn cause extensive damage to the VFDs as well as harmonic resonance with capacitors. Our company was chosen to do a power quality improvement project in those harmonic stricken shops and finally HTQF active power filters were installed on site as the most effective solution.

After installation, the current and voltage waveforms have been improved significantly and the harmonic content dropped considerably. One of the most noticeable improvements is that, the THDv dropped from 10.4% to 3.3%, which was lower than the national standard of 5% set by the Chinese regulation of Quality of Electric Energy Supply - Harmonics in Public Supply Network (GB/T 14549-1993). The drop in THDv of the busbar means enhanced performance, reliability and efficiency of electrical equipment. As for harmonic currents, the THDi decreased from 20.6% to 4.7%, which in turn significantly reduced the resonance caused by the switching of capacitor banks.

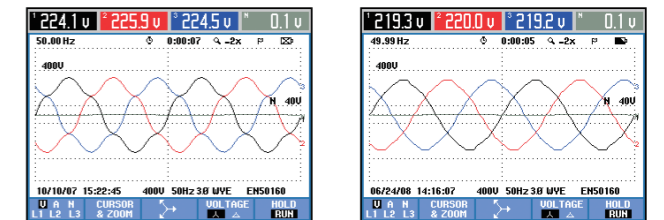

Waveforms and RMS values of phase voltages before and after HTQF APFs were installed

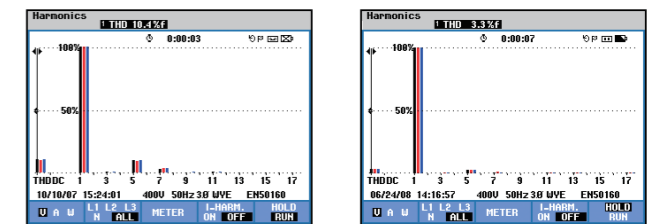

Harmonic spectrum of phase voltages before and after HTQF APFs were installed

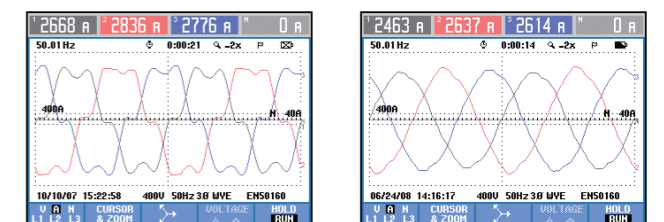

Waveforms and RMS values of phase currents before and after HTQF APFs were installed

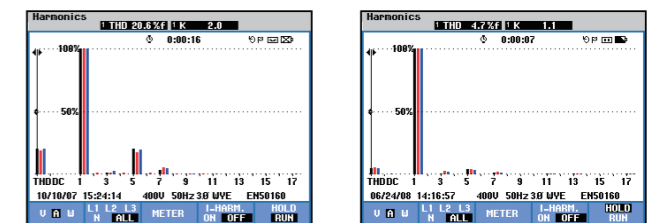

Harmonic spectrum of phase currents before and after HTQF APFs were installed

# OUR CLIENTS

---

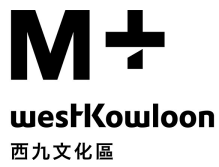

Contact us:

COX International Limited  
Room 03, 10/F, Technology Plaza,  
29-35 Shai Tsui Road, Tsuen Wan,  
New Territories  
Hong Kong

Tel: (852) 3101 2323

Fax: (852) 3101 2320

Website: <http://www.cox-int.com.hk/>

Email: [sales@cox-int.com.hk](mailto:sales@cox-int.com.hk)

